

Product availability: Stock - Normally stocked in distribution facility

Price\*: 561.00 USD



### Main

Range of product	Modicon ABE7
Product or component type	Electromechanical output relay sub-base
[Us] rated supply voltage	24 V DC PLC end
Number of channels	16
Number of terminal per channel	1

### Complementary

Terminal block type	Removable
Polarity distribution	Polarity distribution contact common per group of 8 channels
Fixing mode	By clips 35 mm symmetrical DIN rail) By screws solid plate with fixing kit)
Width	4.92 In (125 mm)
Maximum current per output common	12 A
Current per channel	2 A preactuator end
Minimum switching current	1 mA $\geq$ 5 V
Drop-out voltage	2.4 V 68 °F (20 °C) PLC end)
Switching frequency	$\leq$ 10 Hz $\leq$ 0.5 Hz
Threshold tripping voltage	19.2 V 104 °F (40 °C)
Drop-out current	0.5 MA 68 °F (20 °C)
Maximum power dissipation per channel in W	0.22 W PLC end)
Contacts type and composition	1 NO preactuator end
Maximum switching voltage	250 V AC 50/60 Hz IEC 60947-5-1 30 V DC IEC 60947-5-1
Number of channel per common	8
Electrical durability	500000 Cycles 200 mA 24 V DC-13 10 ms preactuator end) 500000 Cycles 400 mA 230 V AC-15 preactuator end) 500000 Cycles 600 mA 230 V AC-12 preactuator end) 500000 Cycles 600 mA 24 V DC-12 preactuator end)
Electrical reliability	1e-008

Operating time	<= 10 ms coil energisation and NO closing <= 6 ms coil de-energisation and NO opening
Contact bounce time	<= 5 ms 1 NO
Operating rate in Hz	10 Hz no load 0.5 Hz at le
Mechanical durability	20000000 Cycles
[Uimp] rated impulse withstand voltage	2.5 KV IEC 60947-1
[Ui] rated insulation voltage	2000 V
Installation category	II IEC 60664-1
Tightening torque	5.31 Lbf.In (0.6 N.m) flat Ø 3.5 mm
Net weight	0.89 Lb(US) (0.405 kg)

## Environment

Max immunity to microbreaks	5 Ms
Dielectric strength	2000 V IEC 60947-1
Product certifications	DNV UL CSA GL BV LROS (Lloyds register of shipping) EAC
IP degree of protection	IP2x conforming to IEC 60529
Protective treatment	TC
Resistance to incandescent wire	1382 °F (750 °C) 30 s IEC 60695-2-11
Shock resistance	15 gn 11 ms IEC 60068-2-27
Resistance to radiated fields	9.14 V/M (10 V/m) 26000000...100000000 Hz)IEC 61000-4-3 level 3
Resistance to fast transients	2 KV level 3 IEC 61000-4-4
Ambient air temperature for operation	23...140 °F (-5...60 °C) IEC 61131-2
Ambient air temperature for storage	-40...176 °F (-40...80 °C) IEC 61131-2
Pollution degree	2 IEC 60664-1

## Ordering and shipping details

Category	22375 - INTERFACE MODULE(ABA,R,S)
Discount Schedule	CP2
GTIN	03389110545272
Nbr. of units in pkg.	1
Package weight(Lbs)	12.42 Oz (352 g)
Returnability	No
Country of origin	LV

## Packing Units

Unit Type of Package 1	PCE
Package 1 Height	2.76 In (7 cm)
Package 1 width	3.23 In (8.2 cm)
Package 1 Length	5.35 In (13.6 cm)
Unit Type of Package 2	S03
Number of Units in Package 2	30
Package 2 Weight	24.88 Lb(US) (11.285 kg)
Package 2 Height	11.81 In (30 cm)
Package 2 width	11.81 In (30 cm)
Package 2 Length	15.75 In (40 cm)

## Offer Sustainability

Sustainable offer status	Green Premium product
California proposition 65	WARNING: This product can expose you to chemicals including: Lead and lead compounds, which is known to the State of California to cause cancer and birth defects or other reproductive harm. For more information go to <a href="http://www.P65Warnings.ca.gov">www.P65Warnings.ca.gov</a>
RECh Regulation	<a href="#">RECh Declaration</a>
RECh free of SVHC	Yes
EU RoHS Directive	Pro-active compliance (Product out of EU RoHS legal scope) <a href="#">EU RoHS Declaration</a>
Mercury free	Yes
RoHS exemption information	<a href="#">Yes</a>
China RoHS Regulation	<a href="#">China RoHS Declaration</a>
Environmental Disclosure	<a href="#">Product Environmental Profile</a>
Circularity Profile	<a href="#">End Of Life Information</a>
WEEE	The product must be disposed on European Union markets following specific waste collection and never end up in rubbish bins.

## Contractual warranty

Warranty	18 months
----------	-----------

Dimensions

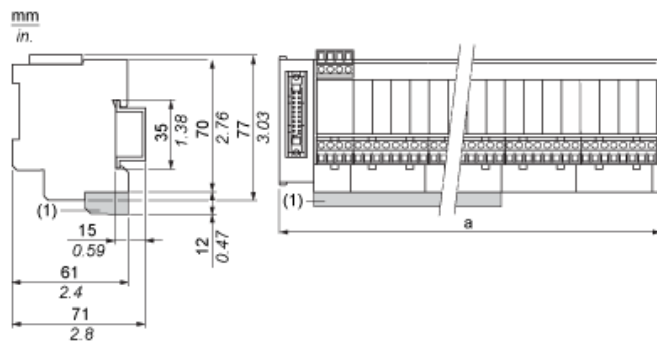

(1) ABE7BV20 / ABE7BV20E

ABE7	a in mm	a in in.
R16S111 / R16S111E	125	4.92
R16S21 / R16S21•E	206	8.11

---

Mounting

---

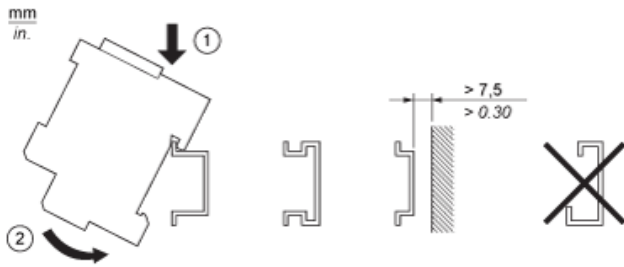

HE10 16 Channels

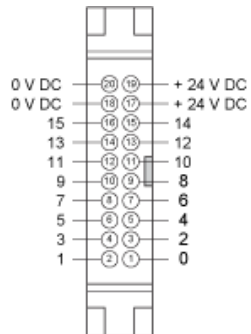

Wiring Diagram

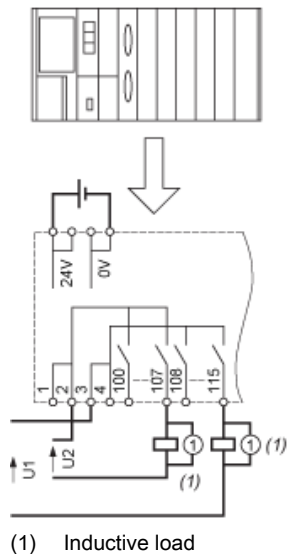

Curves for Determining Cable Type and Length According to the Current

16-channel Sub-base

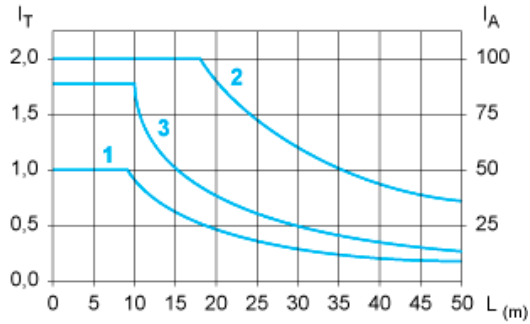

- L Cable length
- $I_T$  Total current per sub base (A)
- $I_A$  Average current per channel (mA)
- (1) TSXCDP••2 and ABFH20H••0 cables with c.s.a. 0.08 mm<sup>2</sup> (AWG 28).
- (2) TSXCDP••3 cables with c.s.a. 0.34 mm<sup>2</sup> (AWG 22).
- (3) Cables with c.s.a. 0.13 mm<sup>2</sup> (AWG 26).

The curves are given for a voltage drop of 1 V in the cable. For n volts tolerance, multiply the length determined from the graph by n.

Temperature Derating Curves

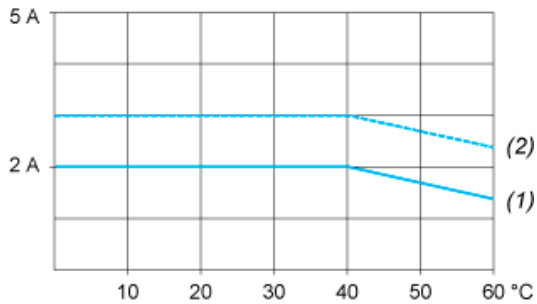

- (1) 100 % of channels used
- (2) 50 % of channels used

Electrical Durability (in Millions of Operating Cycles) Conforming to IEC 60947-5-1

## DC Loads

### DC12 curves

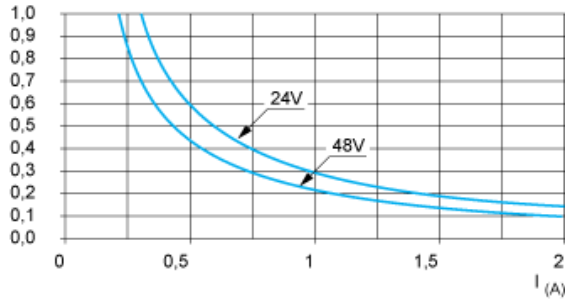

DC12 control of resistive loads and of solid state loads isolated by optocoupler,  $I/R \leq 1$  ms.

### DC13 curves

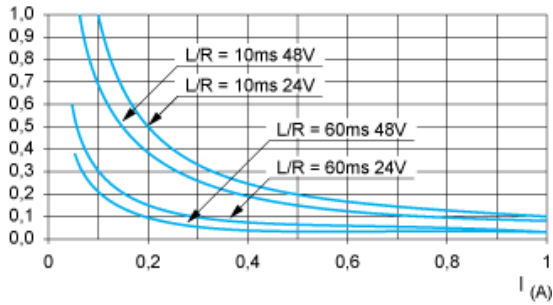

DC13 switching electromagnets,  $L/R \leq 2 \times (U_e \times I_e)$  in ms,  $U_e$ : rated operational voltage,  $I_e$ : rated operational current (with a protective diode on the load, DC12 control).

## AC Loads

### AC12 curves

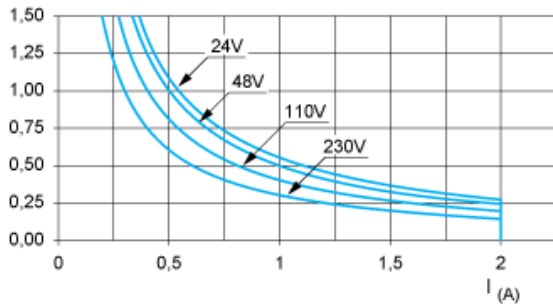

AC12 control of resistive loads and of solid state loads isolated by optocoupler,  $\cos \phi \geq 0.9$ .

### AC14 curves

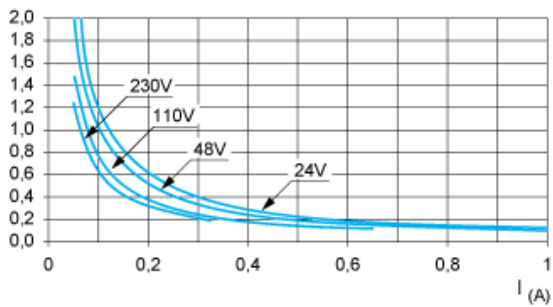

AC14 control of small electromagnetic loads  $\leq 72$  VA, make:  $\cos \phi = 0.3$ , break:  $\cos \phi = 0.3$ .

AC15 curves

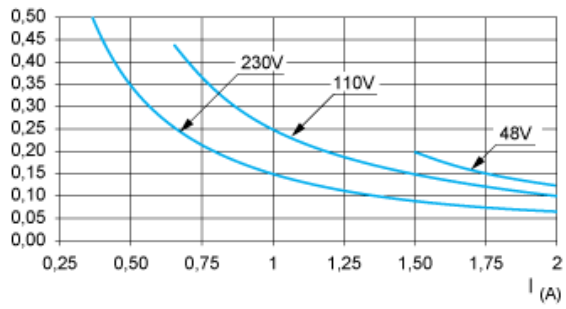

AC15control of electromagnetic loads > 72 VA, make:  $\cos \phi = 0.7$ , break:  $\cos \phi = 0.4$ .

Product Life Status : **Commercialised**